

TWB7 Schubkarre - Aufbauanleitung

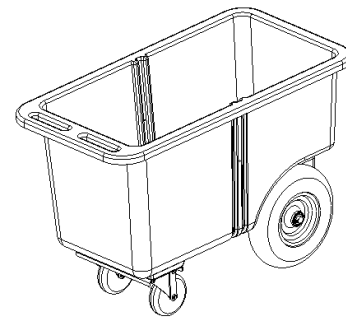

Montagekit enthält:

1

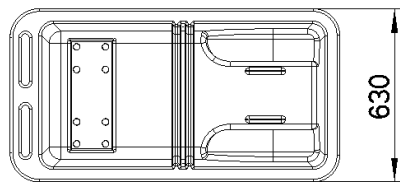
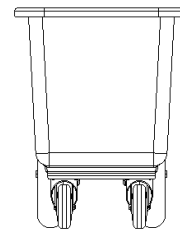
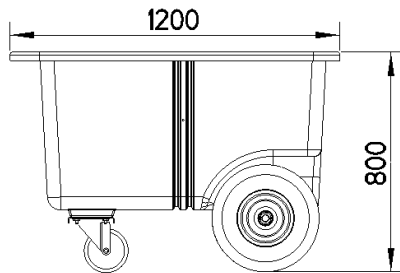
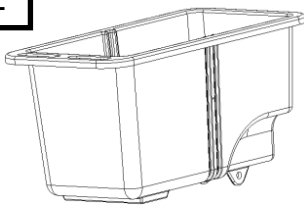

1 X Mulde

2

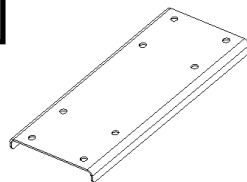

1 X Chassis

3

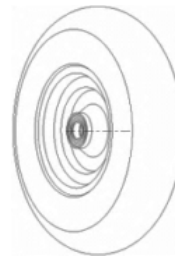

2 X Räder

4

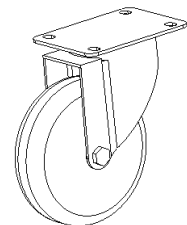

2 X Schwenkrad

5



1 X Axe

6

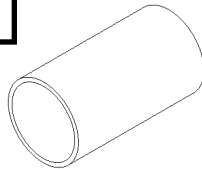

2 X Buchse

7

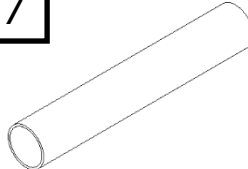

1 X Buchse

8

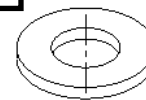

2 X Scheibe

9



Spint

Item	Description	Qty
10	M10 X 30 Schraube	8
11	M10 Mutter	8
12	M10 geriffelte Unterlegscheibe	4

Das Montage-KIT wurde von: _____
geprüft und für Sie bereit gestellt.

Vormontage

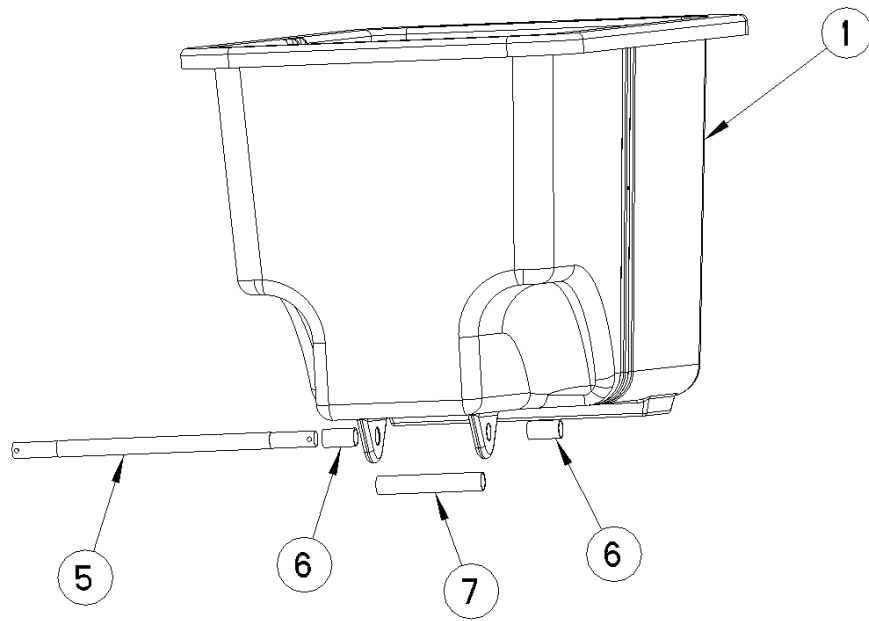

Endmontage

